



INSTRUCTION MANUAL

20 VOLT DUAL COMPONENT SERIES



BEFORE USING NEWBORN 20 VOLT DUAL COMPONENT SERIES, READ, UNDERSTAND AND SAVE ALL SAFETY INFORMATION AND INSTRUCTIONS INCLUDING:

- BATTERY AND CHARGER MANUAL
- NEWBORN INSTRUCTION MANUAL
- INSTRUCTIONS PROVIDED IN MSDS OR MANUFACTURER OF MATERIAL BEING DISPENSED FROM CARTRIDGE

NEWBORN 20 VOLT DUAL COMPONENT SERIES

THE WARRANTY IS NULL AND VOID IF THE TOOL HAS BEEN OPENED OR TAMPERED WITH BY ANYONE OTHER THAN THE DESIGNATED SERVICE REPAIR CENTER.

Note: Do not operate Newborn 20 Volt Dual Component Series until you have read and completely understand the safety and operations sections of this manual.

GENERAL SAFETY RULES

GENERAL SAFETY RULES – FOR ALL BATTERY OPERATED TOOLS:



1. WARNING! READ AND UNDERSTAND ALL INSTRUCTIONS.

Failure to follow all instructions listed below may result in electric shock, fire and/or serious personal injury.

SAVE THESE INSTRUCTIONS

2. WORK AREA

- 2.1 Keep your work area clean and well lit. Cluttered benches and dark areas invite accidents.
- 2.2 Do not operate power tools in explosive atmospheres, such as in the presence of flammable liquids, gases, or dust. Power tools create sparks which may ignite the dust or fumes.
- 2.3 Keep bystanders, children, and visitors away while operating a power tool. Distractions can cause you to lose control.

3. ELECTRICAL SAFETY

- 3.1 Do not abuse the cord. Never use the cord to carry the tool. Keep cord away from heat, oil, sharp edges, or moving parts. Replace damaged cords immediately. Damaged cords may create a fire. (Applies only to tools with a separable battery pack, meaning the battery pack is in a separate enclosure from the tool and connected to the tool by a cord.)
- 3.2 A battery operated tool with integral batteries or a separate Battery pack must be recharged only with the specified Charger for the Battery. A Charger that may be suitable for one type of Battery may create a risk of fire when used with another Battery.
- 3.3 Use Battery operated tool only with specifically designated Battery. Use of any other Batteries may create a risk of fire.

4. PERSONAL SAFETY

- 4.1  **WARNING** - This appliance can be used by children aged from 8 years and above and persons with reduced physical, sensory or mental capabilities or lack of experience and knowledge if they have been given supervision or instruction concerning use of the appliance in a safe way and understand the hazards involved. Children shall not play with the appliance. Cleaning and user maintenance shall not be made by children without supervision.
- 4.2 Stay alert, watch what you are doing, and use common sense when operating a power tool. Do not use a power tool while tired or under the influence of drugs, alcohol, or medication. A moment of inattention while operating power tools may result in serious personal injury.
- 4.3 Dress properly. Do not wear loose clothing or jewelry. Contain long hair. Keep your hair, clothing, and gloves away from moving parts. Loose clothes, jewelry, or long hair can be caught in moving parts.
- 4.4 Avoid accidental starting. Be sure the Variable Speed Power Trigger is in the locked or off position before inserting the Battery. Carrying tools with your finger on the Variable Speed Power Trigger or inserting the Battery into a tool with the Variable Speed Power Trigger on invites accidents.
- 4.5 Remove any adjusting keys or wrenches before turning the tool on. A wrench or a key left attached to a rotating part of the tool may result in personal injury.
- 4.6 Do not overreach. Keep proper footing and balance at all times. Proper footing and balance enable better control of the tool in unexpected situations.
- 4.7 Use safety equipment. Always wear eye protection. Dust mask, non-skid safety shoes, hard hat, or hearing protection must be used for appropriate conditions.

5. TOOL USE AND CARE

- 5.1 Use clamps or other practical ways to secure and support the work piece to a stable platform. Holding the work by hand or against your body is unstable and may lead to loss of control.
- 5.2 Do not force tool. Use the correct tool for your application. The correct tool will do the job better and safer at the rate for which it was designed.
- 5.3 Do not use tool if the Variable Speed Power Trigger does not turn it on or off. A tool that cannot be controlled with the Variable Speed Power Trigger is dangerous and must be repaired.
- 5.4 Disconnect Battery from tool or place the Variable Speed Power Trigger in the locked or off position before making any adjustments, changing accessories, or storing the tool. Such preventative safety measures reduce the risk of starting the tool accidentally.
- 5.5 Store idle tools out of the reach of children and other untrained persons. Tools are dangerous in the hands of untrained users.
- 5.6 When Battery is not in use, keep it away from other metal objects like: paper clip, coins, keys, nails, screws, or other small metal objects that can make a connection from one terminal to another. Shorting the Battery terminals together may cause sparks, burns, or a fire.
- 5.7 Maintain tools with care. Keep cutting tools sharp and clean. Properly maintained tools with sharp cutting edge are less likely to bind and are easier to control.
- 5.8 Check for misalignment or binding of moving parts, breakage of parts, and any other condition that may affect the tool's operation. If damaged, have the tool serviced before using. Many accidents are caused by poorly maintained tools.
- 5.9 Use only accessories that are recommended by the manufacturer for your model. Accessories that may be suitable for one tool may create a risk of injury when used for another tool.

6. SERVICE

- 6.1 Tool service must only be performed by qualified repair personnel. Service or maintenance performed by unqualified personnel may result in a risk of injury.
- 6.2 When servicing a tool, use only identical replacement parts. Follow instructions in the Maintenance section of this manual. Use of unauthorized parts or failure to follow Maintenance Instructions may create a risk of shock or injury.

SPECIFIC SAFETY RULES AND SYMBOLS

ADDITIONAL SAFETY RULES – FOR NEWBORN 20 VOLT DUAL COMPONENT SERIES

7. MATERIAL

- 7.1 Before using any material, be sure to read, understand, and follow the instructions of the manufacturer of that material. Read the MSDS (Material Safety Data Sheet) supplied by the manufacturer of the material and all writing on the material and the container thoroughly. Material may not dispense properly if it is not at the proper temperature. Material may pose a health hazard without adequate ventilation.
- 7.2  **DANGER!** Do not use to dispense any flammable or explosive material, any material that contains petroleum distillate(s), or any material that cannot be used safely near sparks or near electric motors. Do not use this tool, or any other power tool, if any phrases such as “Flammable”, “Explosive”, “Keep away from heat, spark, and flame”, “Keep away from heat, spark, open flames and any ignition source”, “Petroleum Distillate”, “Distillates (Petroleum)”, “Disconnect electric motors”, etc., appear. This product contains an electric motor. All electric motors generate sparks and may ignite vapors from materials.

8. CONDITION OF TOOL

- 8.1 Do not use damaged tools. Lockout or clearly mark “DO NOT USE” until repaired. Many accidents are caused by poorly maintained tools.
- 8.2 Do not alter or modify tool. Any alteration or modification is a misuse and may result in a dangerous condition.

9. MAINTENANCE

- 9.1 Do not disassemble tool or Battery. At conclusion of its useful life, remove Battery from tool. Without further disassembly, return Battery intact for recycling and/or discard tool intact. Disassembly and reassembly may create an unsafe condition.
- 9.2 Do not adjust internal components. This may cause an unsafe condition.
- 9.3 Use only mild soap for cleaning. Other cleaning agents such as gasoline, carbon tetrachloride, ammonia, etc., may damage plastic parts. Do not immerse dispenser, battery, or charger in any liquid, as this may cause damage and unsafe conditions.
- 9.4 Always unplug Charger before cleaning and when it is not in use. Failure to do so may result in shock or fire.

10. OPERATION

10.1 When operating Newborn 20 Volt Dual Component Series, use both hands. Use of both hands will help prevent dropping the tool which could cause damage to the tool or operator.

10.2 Do not place hand, finger, or other foreign objects in front of Pistons while Battery is attached. This could result in injury to operator.

10.3 Do not use any attachments. Use of attachments could cause personal injury or damage to tool.

10.4 Do not operate without Pistons attached. This will damage the cartridge and may be dangerous.

10.5 Use only with Batteries of rated voltage and same type. Higher voltages may create an electrical hazard. Other Battery types may fall from tool, creating a risk of personal injury.

DEFINITION OF SYMBOLS WHICH MAY BE FOUND ON THE TOOL:



Danger, Warning



Direct Current



Keep Hands and Foreign Objects Clear

W

Watts

V

Volts



CE

A

Amps



cCSAus



WARNING - This appliance can be used by children aged from 8 years and above and persons with reduced physical, sensory or mental capabilities or lack of experience and knowledge if they have been given supervision or instruction concerning use of the appliance in a safe way and understand the hazards involved. Children shall not play with the appliance. Cleaning and user maintenance shall not be made by children without supervision.

FUNCTIONAL DESCRIPTION

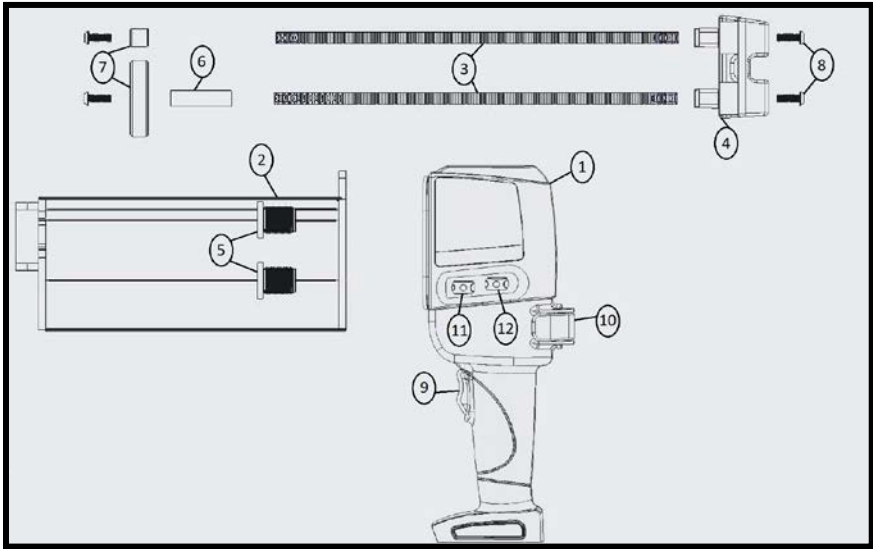

Figure 1

- 1. Power Unit
- 2. Cartridge Retainer
- 3. Racks
- 4. Rack Handle
- 5. Barrel Screws
- 6. Rack Stiffener
- 7. Pistons
- 8. Rack Screws
- 9. Power Trigger
- 10. Clutch Lever
- 11. Speed Control knob
- 12. Dose Control knob

OPERATION

1. Remove and Install Battery Pack:

To remove Battery, squeeze both release buttons and slide the Battery forward.
To insert Battery, slide Battery fully onto the base of the handle.



Figure 2

2. Rack Movement:

As shown in figure 3 below, once the clutch lever is opened the racks are free to move and the tool will not be able to dispense. The racks can also be manually moved forward with the clutch lever closed.

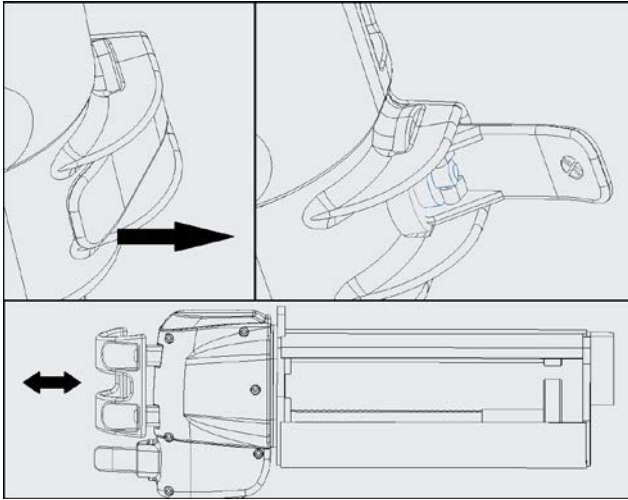

Figure 3

3. Install Cartridge:

To install a cartridge, simply flip the clutch lever open and pull the racks completely back. Place cartridge in cartridge retainer. Flip clutch lever closed and firmly push rack handle forward until the pistons engage the cartridge. (The handle can be pushed forward with the clutch lever still open, but with it closed the racks will be held forward.)



WARNING – Keep all body parts and foreign objects outside of cartridge holder at all times. Fingers can be injured if caught between piston and cartridge holder.

4. Starting and Stopping:

Once the cartridge has been loaded simply press the power trigger to begin dispensing.

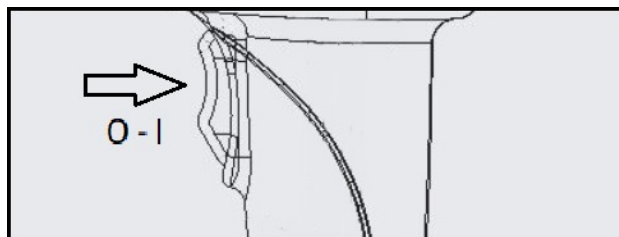

Figure 4

5. Speed and Dose Control:

Speed and Dose can both be adjusted with the corresponding dials on the side of the tool. Both dials have an “off” position when spun all of the way to right. For the dose this disables the dose function and allows the tool to run indefinitely while trigger is pulled. When the speed dial is in the “off” position the tool is completely disabled and will not run.

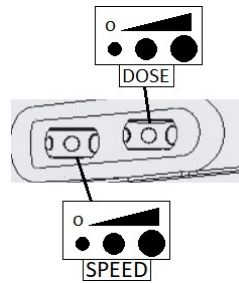



Figure 5

NOTE – To minimize the chance of damage to the cartridge, the dispenser automatically adjusts its output force. You may experience a variation in motor speed associated with this function. If damage or blowby occur, adjust the speed control to a lower setting.

MAINTENANCE

 **WARNING** – To reduce risk of injury, always unplug the Charger and remove the Battery from the Charger or the tool before performing any maintenance. Never disassemble the tool Battery or Charger. Contact a PowerPush® Service facility for all repairs. The Battery must be removed from the tool before disposal. All batteries shall be disposed of safely in accordance with local laws and regulations.

1. Always unplug Charger before cleaning and when it is not in use.
2. Frequent maintenance can prolong the life and safety of the tool. Every year or as necessary (depending on usage of tool), return it to a service center shown in the service center section of this manual for:
 - Electrical and mechanical inspection
 - Cleaning and lubrication
 - Testing to ensure that the electrical and mechanical systems are in proper operation.
3. If Newborn 20 Volt Dual Component Series is not running at full capacity, check to be sure that the Battery is fully charged and that the contacts on the Battery and tool are both clean. If they require maintenance, use caution and clean with an eraser. If your tool is still not operating properly, return all parts including tool, Battery and Charger to a service center shown in the Service Center section of this manual for repair. *Service or maintenance performed by unqualified personnel could result in injury or damage.*
4. Keep handles clean, dry and free of oil or grease. Clean with mild soap and damp cloth. Do not use solvents or cleaning agents that can damage tool.
5. Follow cleaning and maintenance instructions in Battery and Charger manual.
6. Apply light coating of light machine oil to lubricate Racks as needed.
7. For internal lubrication and for all other maintenance/repairs, except external cleaning and Battery recharging, return to qualified Service Center, distributor, or manufacturer.
8. Recycle used Batteries. Comply with all disposal regulations and laws.

ACCESSORIES

These accessories are recommended:

BATTERY:

20 Volt Lithium-Ion Battery 1P 2.0A-h (Part number 1010-018)

CHARGER:

120 Volt AC Charger North America and Japan (Part number 1020-029-US)

220 Volt AC Charger for European Union (Part number 1020-029-EU)

220 Volt AC Charger for United Kingdom (Part number 1020-029-UK)

220 Volt AC Charger for Australia (Part number 1020-029-AU)

FACTORY SERVICE CENTER

MERITOOL SERVICE CENTER

4496 Route 353

PO Box 148

Salamanca, NY 14779 USA

Phone 716.699.6005

Fax 716.699.6337

Monday – Friday 8:00am to 5:00pm Eastern

WARRANTY

THE WARRANTY IS NULL AND VOID IF THE TOOL HAS BEEN OPENED OR TAMPERED WITH BY ANYONE OTHER THAN THE DESIGNATED FACTORY SERVICE CENTER.

The warranty covers the cost of parts for repairing defects in workmanship and materials. All repairs will be completed at the Factory Service Center. Purchaser is responsible for shipping costs to the Factory Service Center. The warranty is valid for up to one year from the date of purchase.